

Quality management system (QMS)  
of LLC «Volya» is certified  
for compliance with  
standard of  
ISO 9001:2008



Certified by  
Russian Registry



# ARCH REINFORCEMENT

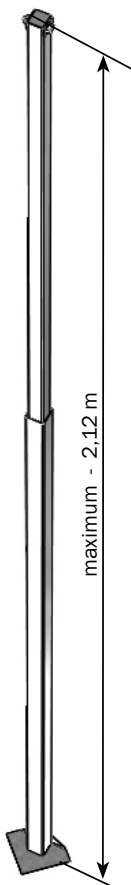

## Description







The arch reinforcement is designed to increase the bearing capacity of the arch of the greenhouse under the snow load.

The arch reinforcement is installed on one arch of the greenhouse. To increase the bearing capacity under the snow load of the frame of the entire greenhouse, these reinforcement should be installed on each arch of the greenhouse, with the exception of the doorway arches.

The dismantling of the arch reinforcement from the greenhouse frame after the winter period is carried out using one bolted connection.

The arch reinforcement is made of galvanized steel pipes. The kit includes everything you need for installation.

### STANDARD SUPPLY SET

№	denomination	q-ty, pcs
1	Stand bottom 25x25 	1
2	Stand 20x20 	1
3	Bracket 	1
4	Coupler 	1
5	4,8x19 self drilling screw 	3
6	M6x30 bolt 	1
7	M6 nut 	1

### Warranty liabilities

1. The manufacturer is responsible for the completeness of the product.
2. The manufacturer is responsible for assemblability of the product in accordance with the instructions.
3. Term for making claims is 12 months from the day of purchase

### Terms of warranty provisions

Warranty does not apply to cases of:

1. Arch reinforcement installation in violation of instruction requirements
2. Floods, hurricanes and other natural disasters.

Production date

Manufacturing facility: LLC "Volya"  
141983, Dubna, Moscow region, Severnyi per., 8.

The manufacturer is responsible for the quality of products in accordance with the RF Civil Code.  
The company reserves the right to make changes in the greenhouse design

# 1

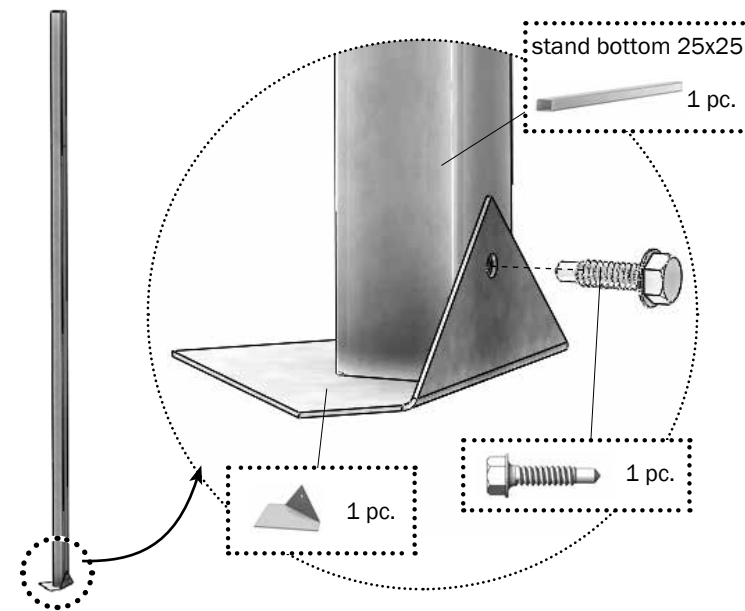

# 2

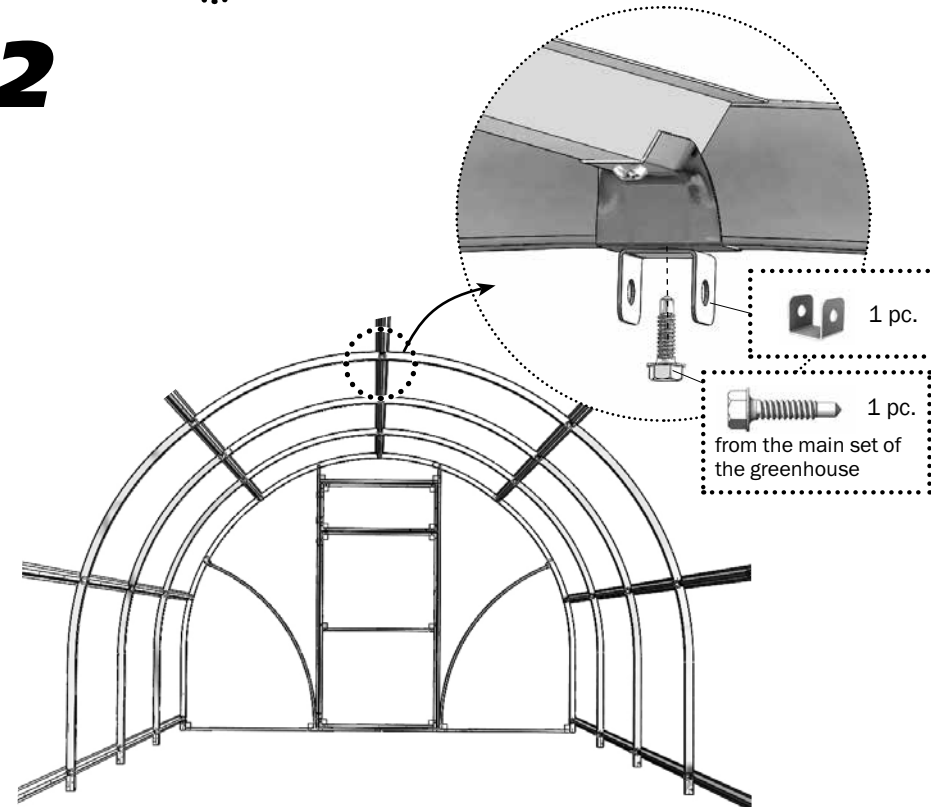

# 3

